

Contents

“
To Migun Family,
 Thank you for purchasing our Thermal-massage bed.
 Please read this manual carefully for safe and effective use of your Migun bed.
 Please keep this manual safe and refer to it when necessary.
 ”

- Important Safeguards
- Warning
- Caution

Features and purpose of HY-7000U	10
Package Contents	11
Designations and Functional Characteristics - Parts	12
Designations and Functional Characteristics - Control Panel	14
Remote Control	16
Operational Modes	18
Frame Assembly	20
Specifications	22
Preparing to Use	23
Operational Instruction	25
Proper Storage and Care	39
Error Message/ Emergency	40
Troubleshooting	41
Expendable Items	42
Replacing Expendable Items	43
Disposing Used Product / Manufacturer's Label	44
Helpful Tips on Using the HY-7000U	45
Memo	46
About After Service	50
Warranty Registration	51

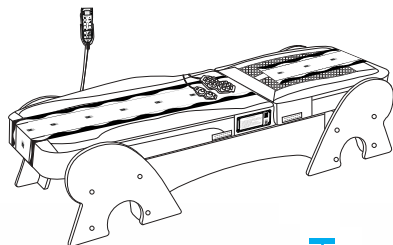

Important Safeguards

Please read this section carefully before using the product. Follow these safeguards since they are for your safety.

This manual classifies 3 types of alerting system depending on the mistreatment of the product.



Danger

If this indication is ignored a severe injury or death may occur.



Warning

If this indication is ignored, an injury or death may occur.



Caution

If this indication is ignored, an injury or property damage may occur.

Call for after service



Warning

- Do not disassemble, repair, or modify the product unless you are a certified technician of Migun. It may cause a leakage of electricity or malfunction of the product.

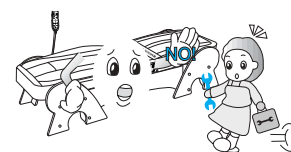

Caution

- Do not disassemble, repair, or modify the product unless this manual allows you to do so. It may cause a leakage of electricity, electric shock, or malfunction of the product.

The contents of this manual may change without prior notice.

- These warnings are provided for users to operate our products safely. Please follow the instructions to avoid any accidents or dangerous situations.
- The symbols specify particular condition or operation may cause possible danger.
- To avoid a possible danger, please read the following warnings carefully and follow them.

Warning

Power Connection and Installation

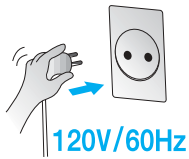

- The rated voltage is AC 120V/60 Hz. Connect to a proper outlet with a ground connection. Otherwise an electric shock may occur when short circuit or a problem with in the product.



- Make a secure connection to the outlet.

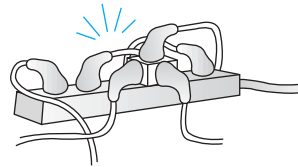

- Do not plug the product with other devices. Fire may start from an overheated power extension cord.

• 120V AC
• more than 15A
• shorter than 5m



- Do not pull the cord to unplug the power plug. Damaged cord may cause an electric shock or fire.



- Do not damage, modify, over-bend, or place a heavy object on the cord. It may cause a leakage of electricity or electric shock. When a power extension cord is needed, the rate of the cord should be as the following:
• 120V AC, more than 15A, and shorter than 5m

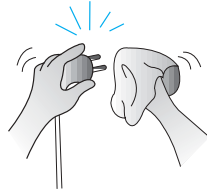

- Keep the power plug clean. A broken or a dirty plug may cause a leakage of electricity or electric shock.

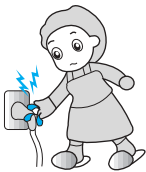

- To avoid electric shock, do not plug or unplug the power plug when your hands are wet.

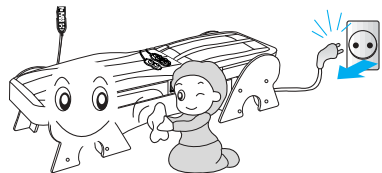

- To avoid electric shock, unplug the power plug before cleaning or maintaining the product.



Warning

Operation and Location

Call for after-sales service

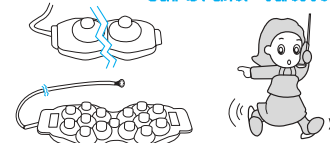

- If a jade massage head or a connection cable is damaged, stop using it immediately and contact the store where you purchased the product from or the Migun headquarter. A continuous use of damaged accessories may cause an electric shock or fire.

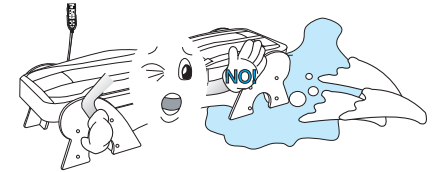

- Do not expose the product to water or operate the product when it's wet. An electric shock may occur.

Do not take a bulb out from the jade

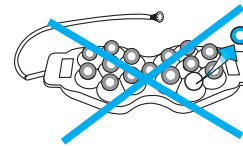

- Do not take any bulb out from the jade massage heads. Otherwise, an electric shock may occur.
- Contact the store where you purchased the product from or the Migun headquarter if you need a replacement.

Call for after-sales service

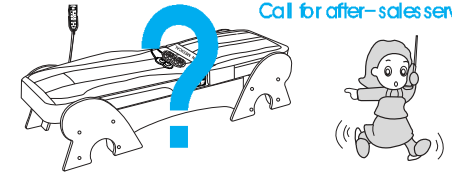

- If there is a problem with the product, stop using the product immediately and contact the store where you purchased the product from or the Migun Headquarter.

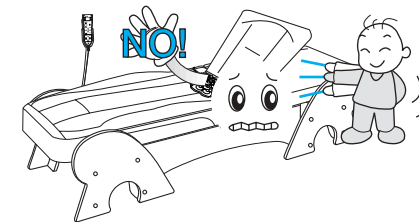

- Do not remove the mattress cover during an operation since the operation will not be stopped. To avoid injury, keep your hands off from the internal parts.

Caution

Power Connection and Installation

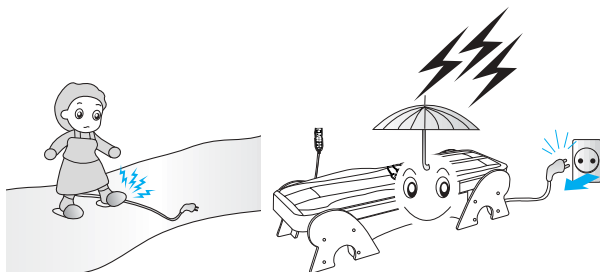

- Do not route the power cord across a walkway.
- Unplug the power cord when there is a lightning or thunderstorm.

• This appliance has a hot surface (Jade massage head). Anyone insensitive to heat must be careful when using the appliance.

• This appliance has to be locked by key on the zipper because there are electrical, & mechanical hazards. When you use it normally, don't open the padlock.

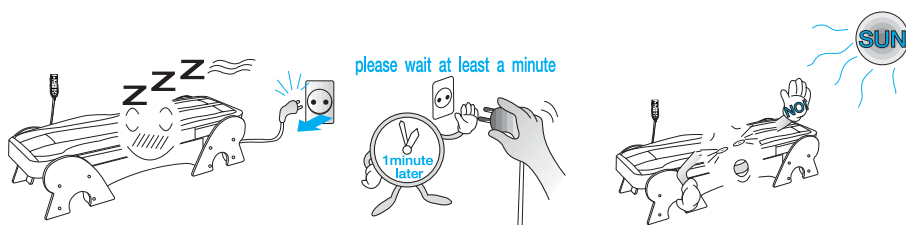

• Unplug the power cord when the product is not in use. This will prevent a leakage of electricity or fire.

• After unplugging the power cord, please wait at least a minute to plug it back in. Otherwise, the product may malfunction due to the overdrive.

• Do not place the product under direct sunlight. Otherwise, the color of the product may fade.

Call for after-sales service

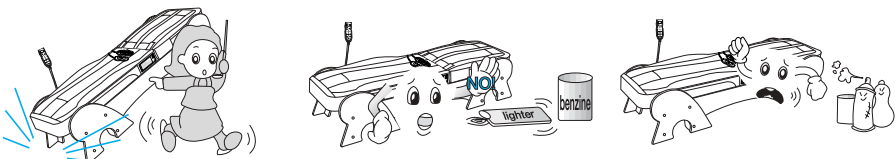

• If the product was dropped or hit during shipping and handling, contact the store where you purchased the product from or the Migun Headquarter before using it.

• Do not place flammable materials near the product. Fire may occur.

• Corrosive materials such as acid should be stored far from the product. It might cause malfunctioning of the product.

Caution

Operation and Location

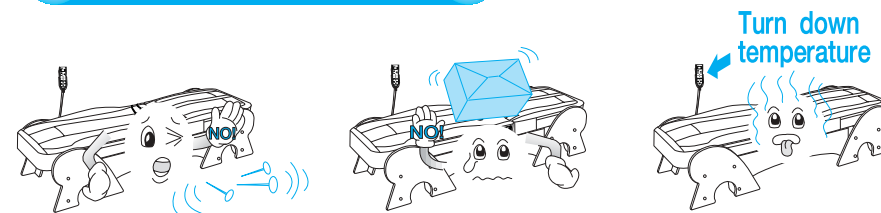

• Do not let a sharp object touch the product. It may cause damage or malfunctioning of the product.

• Do not place anything on the product for storage. It may damage the objects while in operation.

• Turn down temperature when it's too hot or you may get burned from the excessive heat.

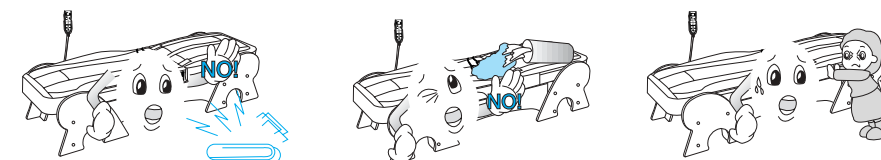

• Do not let small objects such as paper clips or staples get into the product. It may cause damage or malfunctioning of the product.

• Do not bring beverage near the product. Spilt beverages may cause malfunctioning or fire by shorting the circuit out.

• Do not apply excessive force to the product during an operation. It may cause damage or malfunctioning of the product.

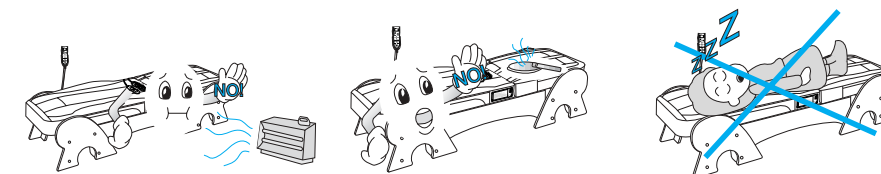

• Do not place the product close to fire or heating device. It may cause an electric shock or fire.

• Do not smoke near the product during an operation. The ashes may cause malfunctioning or fire.

• Be careful not to fall asleep while receiving a treatment. The intensity of a treatment may burn your skin if not monitored carefully.

Please read the operational instruction carefully before using the product.

Caution

Keep children away from the product. The following dangers may occur.



• Children may choke if they wind a cable or a cord around their neck.

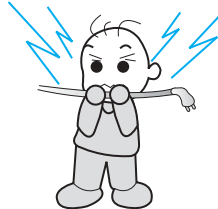

• An electric shock or fire may occur if a child bites the power cord or scratches it with a knife.



• Children may get hurt by dropping an external jade massage head.

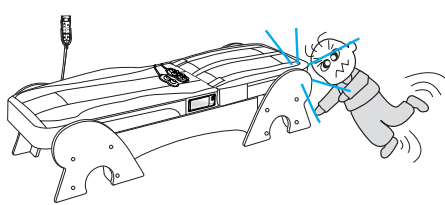

• Children may fall and get hurt from the edge of the product.

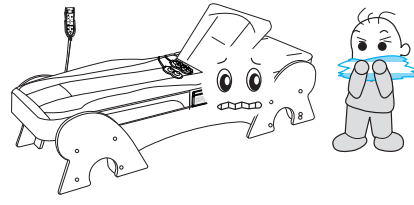

• If a mattress cover is opened, children may choke by stripping and swallowing the sponge.

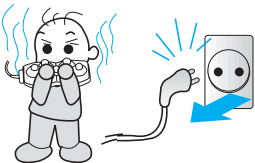

• Turn off the main power when you are not using the product. Children may burn their mouth by putting a heated jade massage head in their mouths.

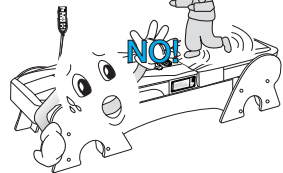

• Do not let children play on the product. They might be injured and may damage the product as well.

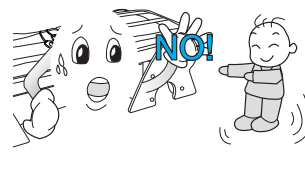

• Keep children away from an operating product.
• Their careless manipulation may cause fire or an electric shock.

Caution

Before Using The Product.

- Follow the recommendation of your doctor.
- Consult with a doctor if you have following health conditions:



- 1 acute diseases
- 2 malignant tumors
- 3 high fever
- 4 heart problems (especially if using a pace maker).
- 5 visual problems
- 6 pregnant
- 7 skin problems
- 8 artificial organs or skeletons.

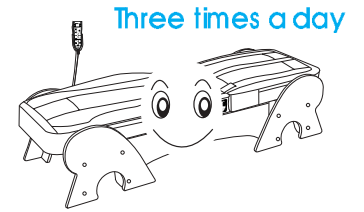

• We recommend you use less than three times a day.



• If you want to use the product more than once a day, have at least 4 hours of recess in between.

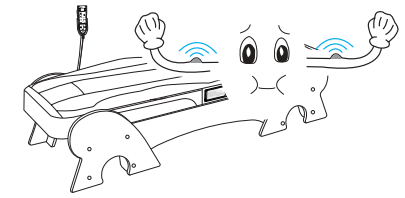

• Do not use the product for purposes other than improving health.

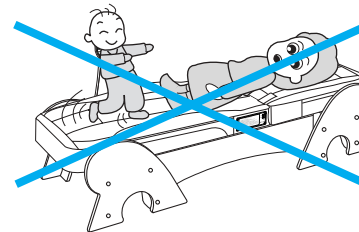

• Do not use the product when you are not properly positioned for a discomfort or problem may occur to your back. (Your head should be 8cm below from the edge of the product.)

Call for after-sales service

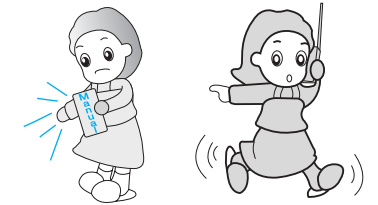

• If you have questions that are not answered by this manual, contact the store where you purchased the product from or the Migun headquarter before using the product.

Migun is always making timeless effort in caring for our customer's safety and health.



Features and purpose of HY-7000U

Features of HY-7000U

- Please read this manual carefully before using the product, and contact the store where you purchased the product from or the Migun Headquarter if you have any questions.
- The treatment area of the main body has been extended to cover to the lower hip area.
- The treatment area of the lower body has been designed to cover from the thigh to the ankle, thereby treating the entire body.
- Users can choose from seven operational modes. (Refer to operational modes on pg. 18 ~19)
- The external jade massage heads can be applied on desired areas effectively.
- Depending on the selected operational mode, moving speed of the internal jade massage heads changes between low, middle, and high settings.
- A simple click of the remote control makes the operation easy and quick.

The Purpose of HY-7000U

Migun has dedicated itself to research and development of products that will make human life healthier and achieve a life span of 100years of age. Migun's purpose for making HY-7000U is to improve health, and the product shall not be used for any other purposes.



Package Contents

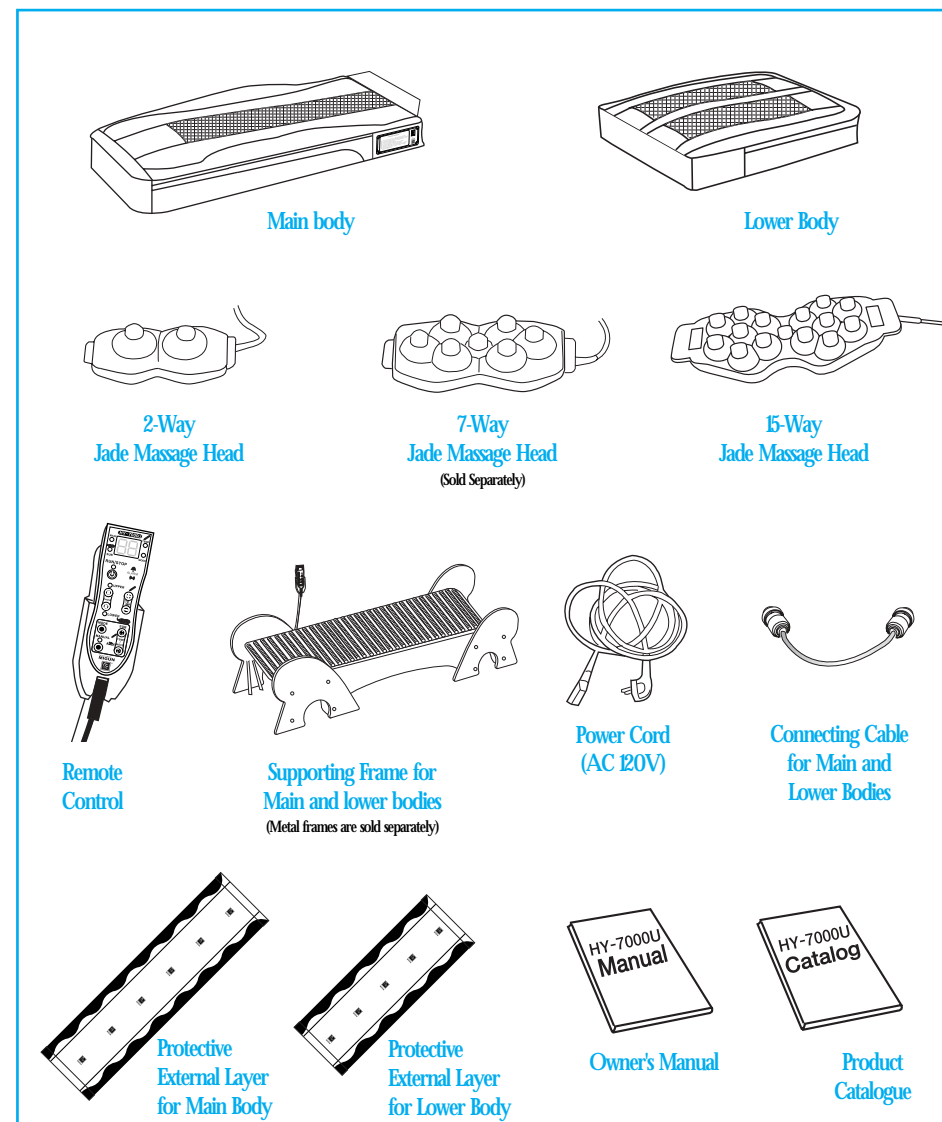



Designations and Functional Characteristics - Parts

1 Remote Control



It controls temperature settings of all jade massage heads and movements of the internal jade massage heads. It can be easily stored in the supporting frame for the remote control.

2 Protective External Layer

It protects the internal jade massage heads and can be detached for cleaning.

3

Supporting Frame for Main and lower bodies

An ivory color frame would go well with any color of your furniture.

4 External Jade Massage Heads



They provide a thermal treatment to any desired area of the body.

5 Connection Terminals

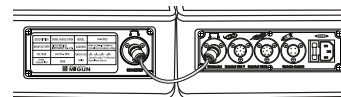

It contains terminals for the lower body, power supply, external jade massage heads, and remote control connecting cables.

6 Lower Body

Two internal jade massage heads provide a thermal and massage treatment to your lower body according to the selected operational mode.

7 Main body

Two internal jade massage heads provide a thermal and massage treatment to your upper body according to the selected operational mode.

8 Main Power

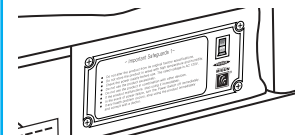

It connects to a power outlet.

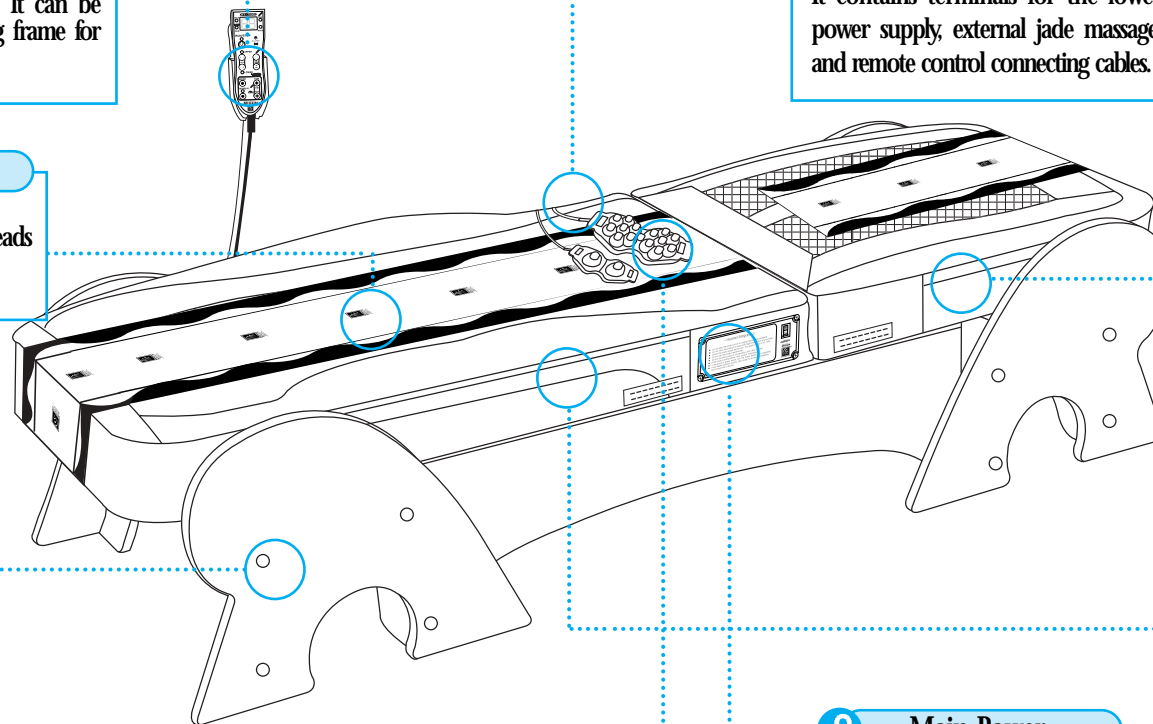



Designations and Functions - Control Panel

Main body Label Panel

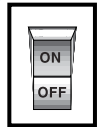
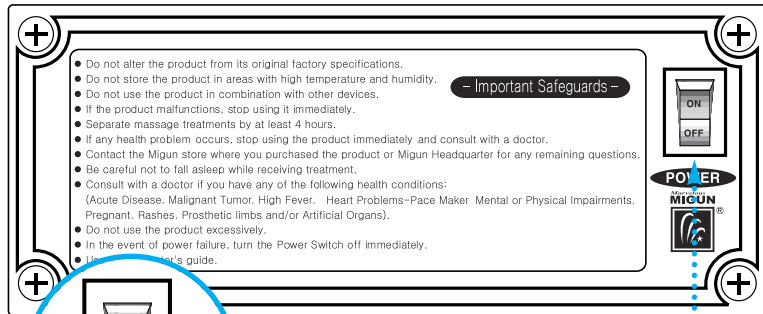

POWER

Main Power Switch: Turns the product on or off.

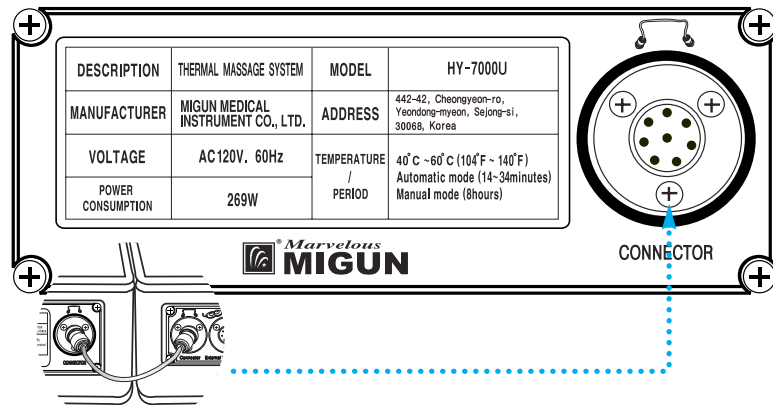

Power Connection Panel

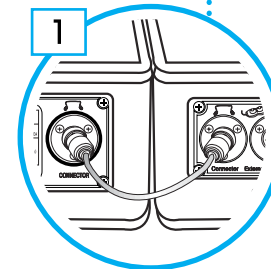
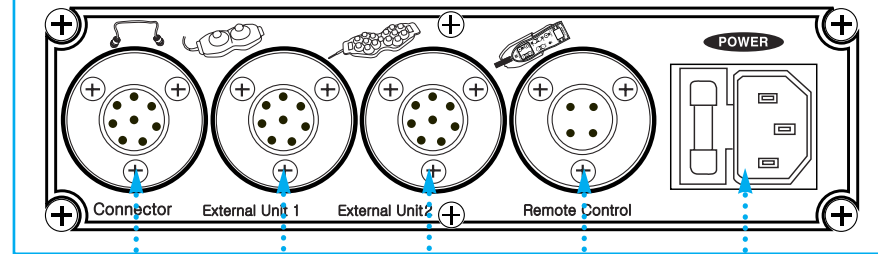

1
Connection terminal
Connects to the lower body

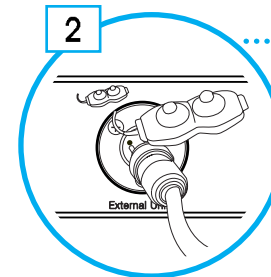

2
External Unit terminal 1
Connects to a external jade massage head

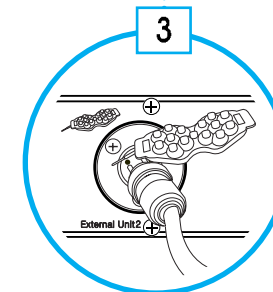

3
External Unit terminal 2
Connects to a external jade massage head

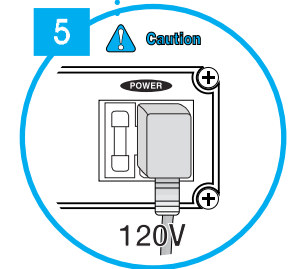

5 **Caution**
Power terminal
Connects to an AC 120V outlet

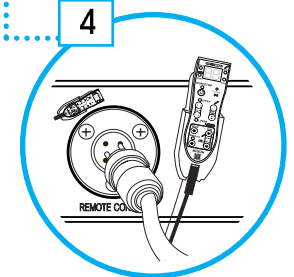

4
Remote Control terminal
Connects to the remote control



Remote Control

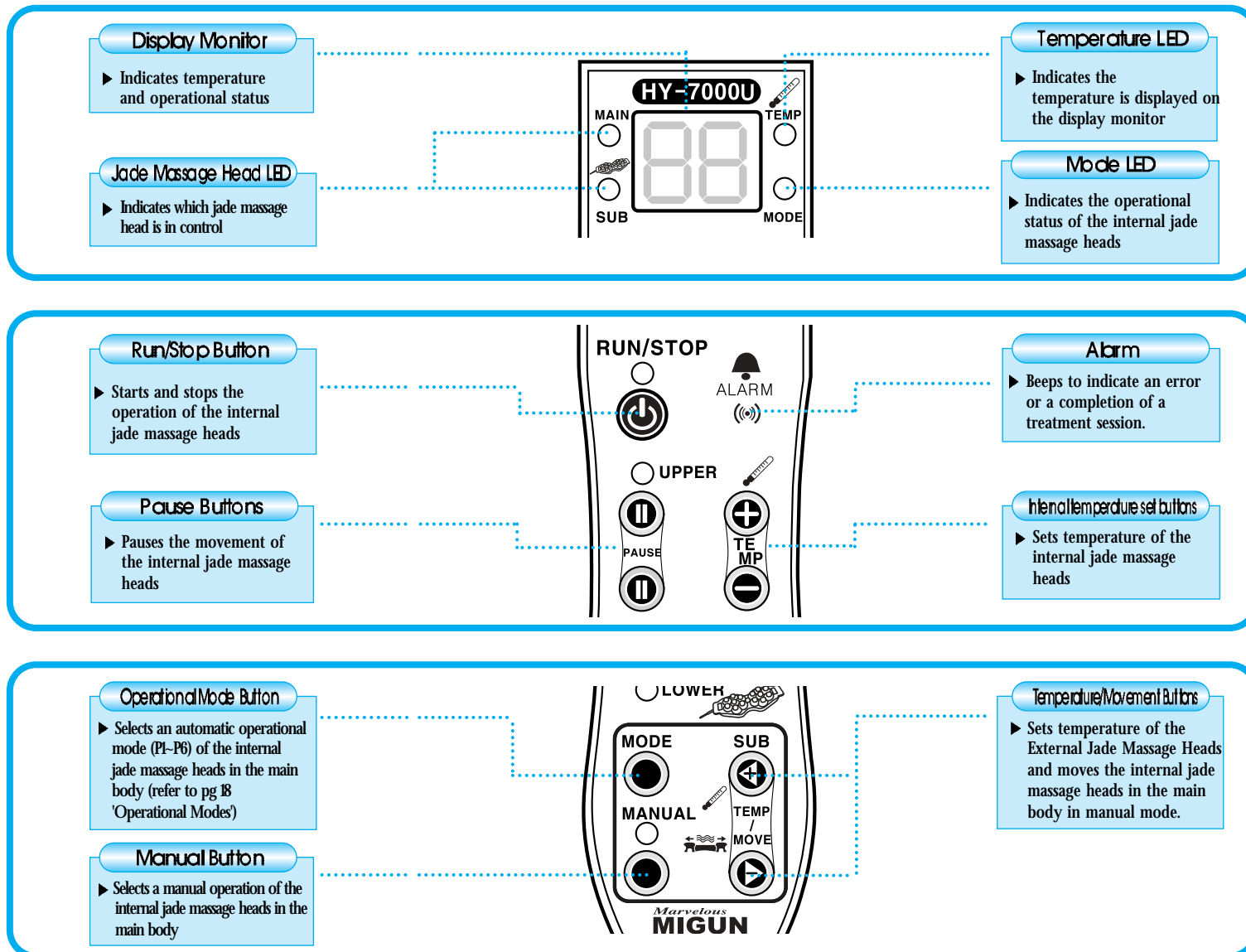
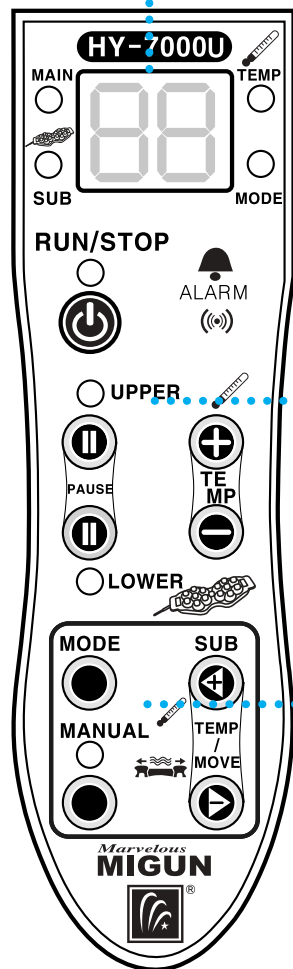



Operational Modes



Please read the following section carefully to use the product safely and effectively.



Operational Modes of HY – 7000U

Operational Mode 1 (P1) Basic Massage	1. Operation of the Main body (Main Treatment) • This mode is a special operational mode that is uniquely designed from Migun's technology. • This mode automatically applies a thermal, massage, and finger-pressure treatment on your entire upper body. 2. Operation of the Lower Body (Supplementary Treatment) • This mode automatically applies a thermal, massage, and finger-pressure treatment on the entire lower body.
Operational Mode 2 (P2) Dorsal Massage	1. Operation of the Main body (Main Treatment) • This mode automatically applies a thermal, massage, and finger-pressure treatment, concentrating on your neck and dorsal area. 2. Operation of the Lower Body (Supplementary Treatment) • This mode automatically applies a thermal, massage, and finger-pressure treatment on the lower body area and the sole of the foot. A desired moving area can be programmed.
Operational Mode 3 (P3) Lumbar Massage	1. Operation of the Main body (Main Treatment) • This mode automatically applies a thermal, massage, and finger-pressure treatment, concentrating on your lumbar area. 2. Operation of the Lower Body (Supplementary Treatment) • This mode automatically applies a thermal, massage, and finger-pressure treatment on the entire lower body.
Operational Mode 4 (P4) Finger Pressure	1. Operation of the Main body (Main Treatment) • This mode automatically applies a finger-pressure treatment on your entire upper body. This operation finishes with massage treatments. 2. Operation of the Lower Body (Supplementary Treatment) • This mode automatically applies a thermal, massage, and finger-pressure treatment on the entire lower body.

Operational Modes of HY – 7000U

Operational Mode 5 (P5) General Massage	1. Operation of the Main body (Main Treatment) This mode automatically applies a massage treatment on your entire upper body. Speed of the movement changes automatically between Low, Middle, and High setting. 2. Operation of the Lower Body (Supplementary Treatment) This mode automatically applies a thermal massage, and finger-pressure treatment on the entire lower body.
Operational Mode 6 (P6) Abdomen Massage	1. Operation of the Main body (Main Treatment) This mode automatically applies a thermal massage, and finger-pressure treatment, concentrating on your abdomen area. (This mode is laid face-down.) 2. Operation of the Lower Body (Supplementary Treatment) This mode automatically applies a thermal massage, and finger-pressure treatment on the entire lower body.
Operational Mode 7 (P7) Manual Massage	1. Operation of the Main body (Main Treatment) This mode applies a thermal massage, and finger-pressure treatment on the entire or a specific area of your upper body by manually controlling the Internal Jade Massage Heads. 2. Operation of the Lower Body (Supplementary Treatment) This mode applies a thermal massage, and finger-pressure treatment on the entire or a specific area of your lower body by manually controlling the Internal Jade Massage Heads.

※ Note: A treatment takes from 14 minutes to 40 minutes except for the Manual Operation (P7), and depending on the weight of a user or input power, there can be an error of ±7%.

<System Features>

- Uses state-of-the-art micro controller
- Controls movement and temperature accurately
- Sets temperature (increment of 5°C) and displays it (accuracy of 1°C)
- Operates main body and lower body simultaneously or separately
- Each external jade massage head connecting cable can be connected to any terminal
- Indicates error codes (for an easy service)



How to assemble the frame of HY-7000U

Step 1 Necessary Parts

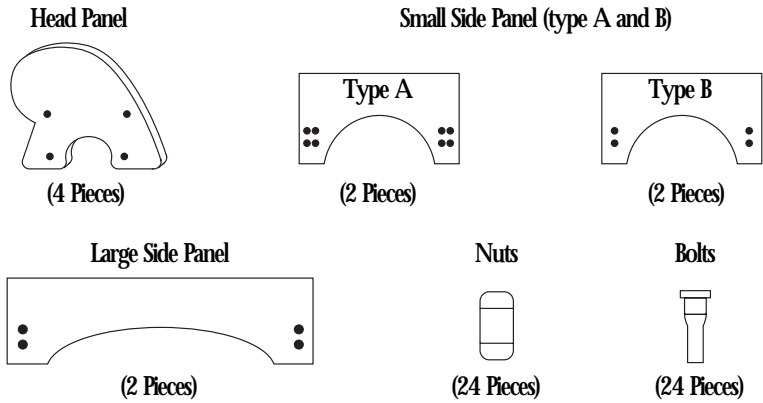

Step 2

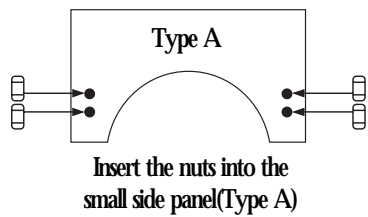

Step 3

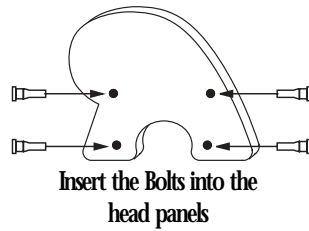

Step 4

Attach the head panel with the small side panels as shown

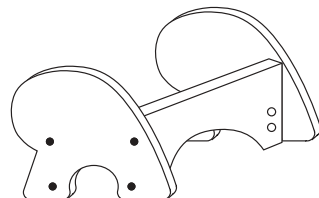

Step 5

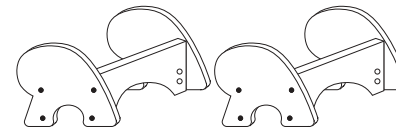

Do the step 2 to step 4 to make one more

Step 6

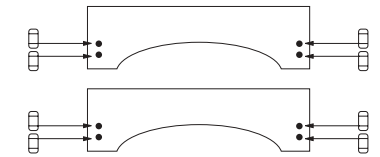

Insert the nuts on the large side panels.

Step 7

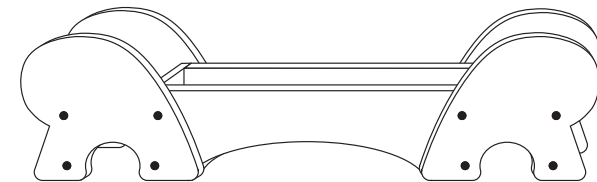

Attach the large side panels to the preassembled one as shown.

Step 8

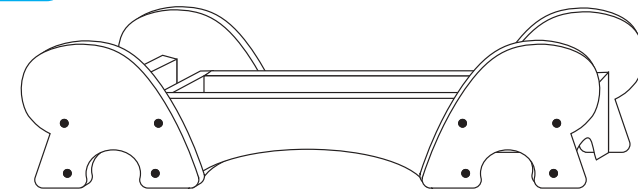

Attach the small panels (Type B) as shown to finish the assembly.



Specifications

Operating Condition	Supply Voltage	AC 120 V	
	Power Consumption	269W maximum	
	Frequency	60 HZ	
	Operating Temperature	40 °C ~ 60 °C (104 °F ~140 °F)	
External Dimension	Length	2,000mm (6.56 ft)	Main Body 1200mm(3.94 ft)
			Lower Body 800mm(2.62 ft)
	Width	700 mm (2.30 ft)	
	Height	120 mm (0.39 ft)	
Weight	Main body	32.56 kg (71.7 lbs)	
	Lower Body	21.33 kg (47.0 lbs)	
	Frame	22.68 kg (49.8 lbs)	
	Total	76.57 kg(168.5 lbs)	



Preparing to use

Notes

1. Install the product on a flat surface. Otherwise, the operation may be noisy and/or your spine may be ill positioned.
2. Do not install the product in areas with moisture and dirt. It may be harmful for the product.
3. The rated voltage is 120V/60Hz. The power plug should be plugged into an ac 120V outlet that has a ground connection.
4. When a power extension cord is needed, the cord should be rated with 120V AC, more than 15A, and less than 5m in length. Do not route the power cord across a walkway or put a heavy object on the cord.
5. Do not place the product under direct sunlight.
6. Assemble parts with provided orders.

1

Room temperature should be between 50~86°F (10~30°C), and humidity should be between 35~80%.

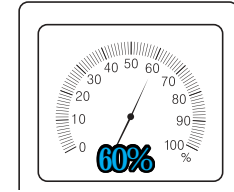
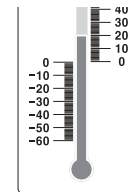

2

- a Place the supporting frame for main and lower bodies on a flat and secure surface (refer to pg 20, frame assembly)
- b Put the main and lower bodies correctly on the frame.
- c Plug the connecting cable for main and lower bodies to the connection terminal and secure the locking cap by turning it clockwise.
- d Plug the remote control cable to the remote control terminal and secure the locking cap by turning it clockwise.

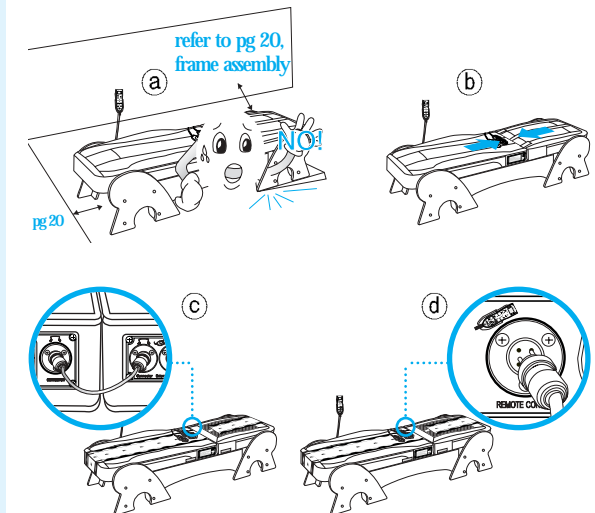



Preparing to use

3

- Plug the connecting cables for the external jade massage head 1 and 2 to the external unit terminal 1 and 2, and secure the locking caps by turning them clockwise.
- * Note: any of 2-way, 7-way, and 15-way external jade massage head can be plugged into either external unit terminals.

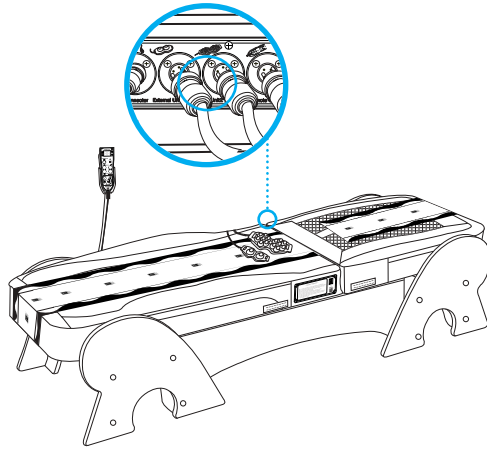

4

- Connect the power cord to the power terminal on the connection panel.
- Make sure the supplied voltage is AC 120V/ 60Hz.
- Plug the power plug to the outlet.

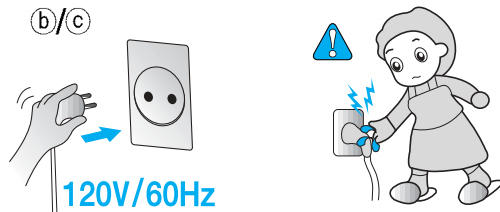
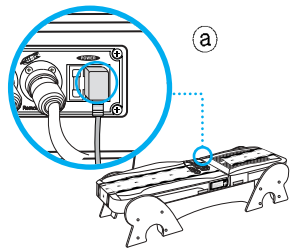

Caution

Do not plug or unplug the power plug when your hands are wet.



Operational Instruction



Cautions while operating the product

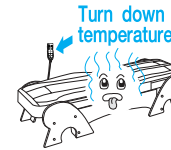

- Do not set temperature excessively high. It may cause malfunctioning of the product or possibly a skin burn.

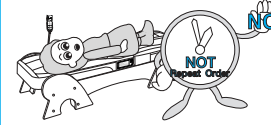

- Do not apply thermal treatment on one spot extensively. Otherwise it may cause a skin burn.

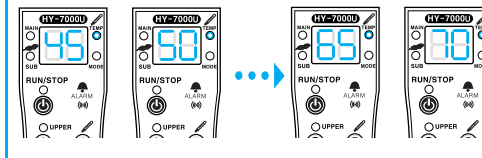

- Start from low temperature and gradually increase to high temperature to avoid skin burn.

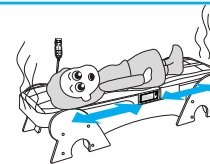

- When you feel uncomfortably hot on one location, relocate to different area.



- Keep children away from the operating product. Their skin is very sensitive to heat.



Operational Instruction

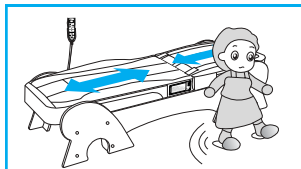

• Do not leave operating product alone.



• Do not disassemble, repair, or modify the product on your own. It may cause fire or electric shock.

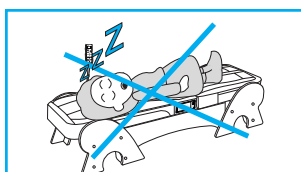

• Be careful not to fall asleep while receiving a treatment. The intensity of a treatment may burn your skin if not monitored carefully.

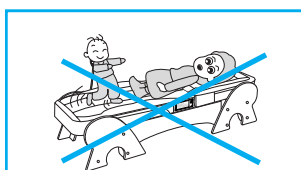

• Do not use the product when you are not properly positioned on the product. A severe damage may occur to the product.

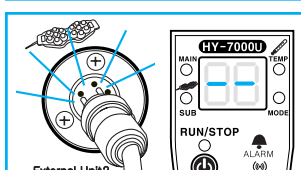

• An error code of 「—」 would appear on the display monitor when the external jade massage head is not properly connected and the 'temp/movement' button is pressed. Check the connections to the external jade massage heads.

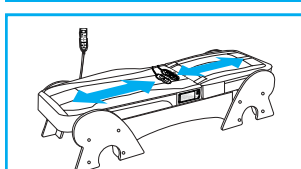

• Connecting and disconnecting the external jade massage heads will not affect the operation of the internal jade massage heads.

Automatic Operation

In Default Operation

1

Turn on the 'main power' switch located on the main body label panel. ("00" will appear on the display monitor. If the product is left on for more than 8 hours, it will automatically be turned off for safety purpose.)

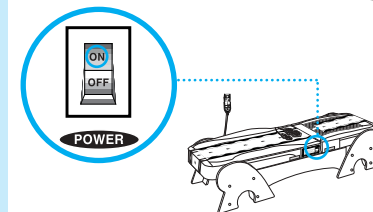

2

Lay down comfortably on the thermal massage bed. (Please allow 8cm of distance from the edge of the bed to the top of your head.)

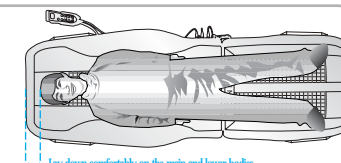

Lay down comfortably on the main and lower bodies.

3

- ① Press the 'run/stop' button on the remote control.
- ② The 'run/stop' LED light will appear in green.
- ③ The set temperature of main body will appear on the display monitor. The temperature LED and the internal jade massage head LED, (located on each side of the display monitor) will light up in green.
- ④ The display monitor will alternate between selected operational mode and present temperature of the internal jade massage heads.
- ⑤ Unless you press the remote control for another setting, the product will automatically start with its default settings. When the internal jade massage heads move, the operational mode LED will blink in green.

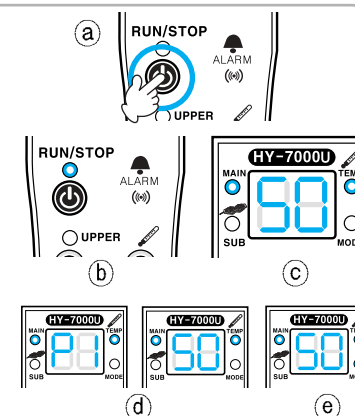

- Main body - automatic, operational mode 1, basic temperature set to 50°C (122°F)
- Lower body - automatic, basic temperature set to 50°C (122°F)



Operational Instruction

In Default Operation

4

- a) To pause the movement of the internal jade massage heads in the main body, press the 'upper pause' button.
- b) The main pause LED will light up in red.
- c) To resume the movement, press the same button again.
- d) The internal jade massage heads will start moving after the main pause LED turns off.

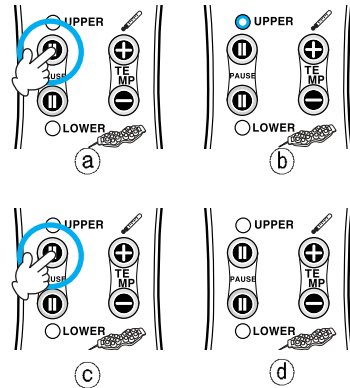

5

- a) To pause the movement of the internal jade massage heads in the lower body, press the 'lower pause' button.
- b) The lower pause LED will light up in red.
- c) To resume the movement, press the same button again.
- d) The internal jade massage heads will start moving after the lower body LED turns off.
- e) The product will beep when the selected operational mode is completed.

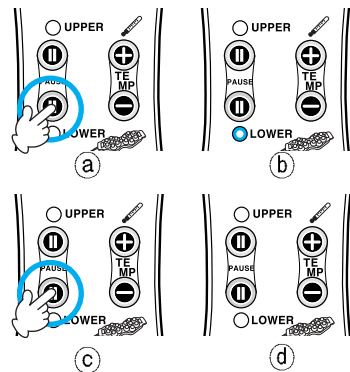

(If the internal jade massage head is remained paused for more than 2 minutes, the internal jade massage heads would be turned off for safety purpose. To turn on the internal jade massage heads again, just press any internal temperature set button.)

In Default Operation

6

- Turn off the main power switch when a treatment session is completed.
- If the power is not turned off, the selected operational mode will be saved for the next session.
- If the power is turned off, the operational mode 1 (P1) will be saved as a default for the next session.
- When the 'run/stop' button is pressed, the saved operational mode will resume.

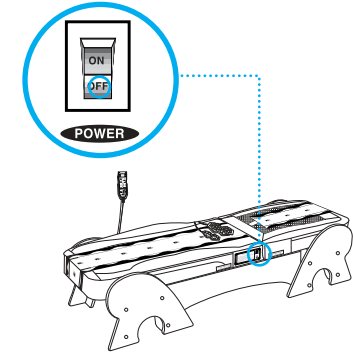



Operational Instruction

To Select Operational Mode (Mode 1 – Mode 6) of Main body

1

- a) Press the 'run/stop' button on the remote control.
- b) The temperature set for the internal jade massage heads will appear on the display monitor.

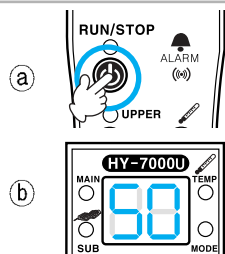

2

- a) Press the 'Operational Mode' button once. The mode number from the previous operation would appear on the display monitor. Keep pressing the Operational Mode Button until a desired mode (P1-P6) appears.
- b) Unless you press any button on the remote control for another setting the present temperature of the internal jade massage heads will appear on the display monitor, and the product will automatically start to operate with the selected operational mode. (If a different operational mode is selected during the operation, it will start the selected operational mode from the beginning. The 'pause' buttons will not work when the internal jade massage heads in the main body are relocating to the starting point (head area) to start the newly selected operational mode.)
- c) If the power is not turned off after a completion of treatment session, the selected operational mode is saved for the next session. (If the power is turned off, the operational mode 1 (P1) will be saved as a default for the next session.)
- d) When the 'run/stop' button is pressed, the saved operational mode will be started.

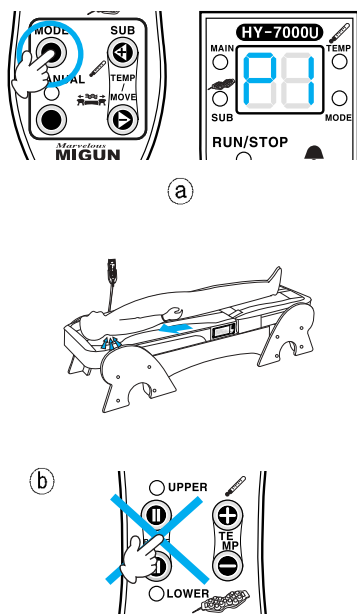

To Set Massage Area for Lower Body for Operational Mode 2 (P2)

1

- a) Press the 'run/stop' button on the remote control.
- b) The temperature set for the internal jade massage heads will appear on the display monitor.

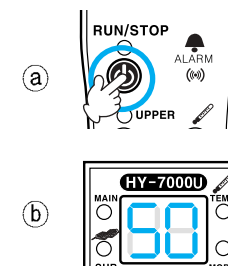

2

- a) Press the 'Operational Mode' button once and the mode from the previous operation would appear on the display monitor. Keep pressing the Operational Mode Button until the operational mode 2 (P2) appears.
* In the operational mode 2 (P2), the lower body will massage the entire lower body by default.
- b) To position the jade massage heads in the lower body, press the lower pause button when it comes to a desired position. The lower pause LED will light in red.
- c) After the jade massage heads in the lower body pause for a short time, they will start massaging on the set area.

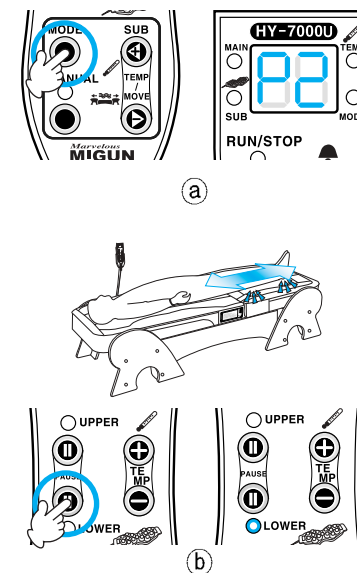



Operational Instruction

To Change Temperature of Internal Jade Massage Heads

1

- a) Press the 'run/stop' button on the remote control.
- b) The temperature set for the internal jade massage heads will appear on the display monitor.

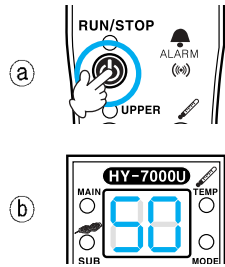

2

- a) Press any internal temperature set button once.
- b) The temperature set for the internal jade massage heads from the previous operation will appear on the display monitor.

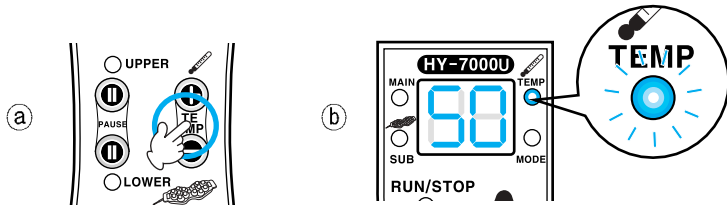

3

Select desired temperature by pressing either 'up' or 'down' button of the internal temperature set buttons.

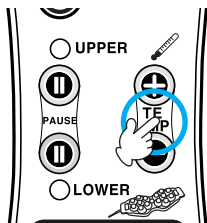

4

To Change Temperature of Internal Jade Massage Heads

- * The range of temperature is between 40–60°C (104–140°F) with an increment of 5°C
- * Unless you press an internal temperature set button, the display monitor will alternate between selected operational mode and present temperature of the internal jade massage heads.

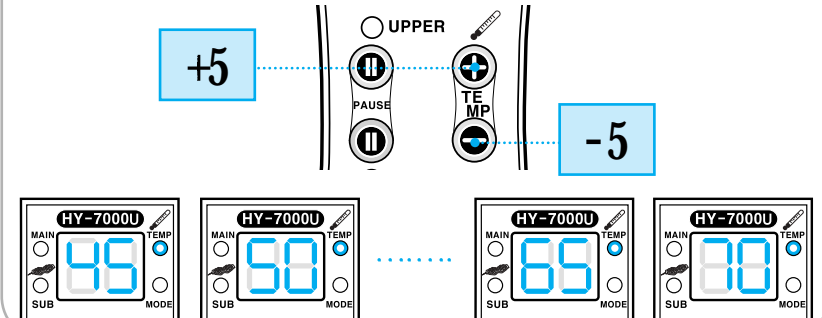

5

The internal temperature set button simultaneously controls temperature of the main and lower body. Temperature may be changed any time during the operation without effecting the program.

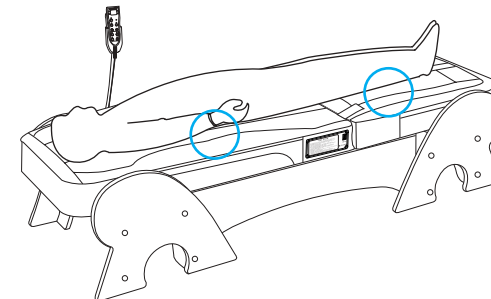



Operational Instruction

Manual Operation

To use Main Body Manually (P 7)

1

- a) Press the 'run/stop' button on the remote control.
- b) The temperature set for the internal jade massage heads will appear on the display monitor.

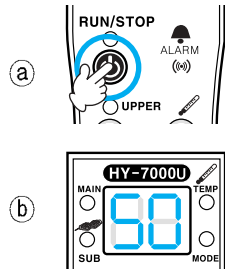

2

- a) Press the manual button located on the lower left side of the remote control.
- b) The manual operation LED will light up in green.
- c) Manual operation (p7) will appear on the display monitor.
- d) The internal jade massage heads will stop moving.

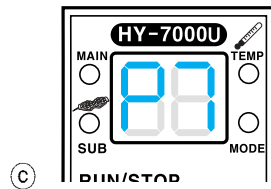
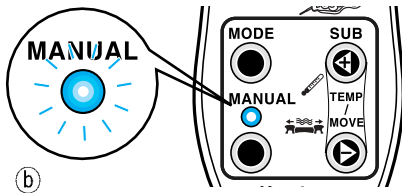
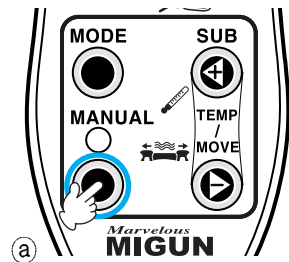

3

- a) When the 'temperature/movement' down button (located on the lower right side of the remote control) is pressed, the internal jade massage heads in the main body will move to the lower back area.
 - b) When the 'temperature/movement' up button is pressed, the internal jade massage heads in the main body will move to the head area.
- * The lower body will remain in the automatic operational mode selected from the previous operation.
 * In manual mode, temperature of the external jade massage heads will remain same as the temperature set from the previous operation.

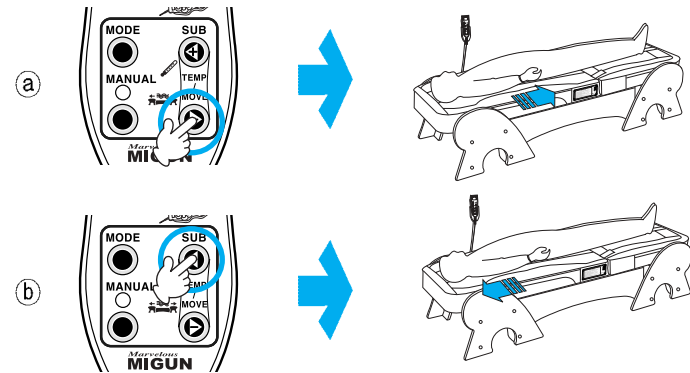

4

- a) To stop the manual operation, press the manual button again.
- b) The manual operation LED will be turned off, and the product will start the automatic operation selected from the previous session.





Operational Instruction

To Use External Jade Massage Head 1 and 2

1

Turn on the main power switch located on the main body label panel.

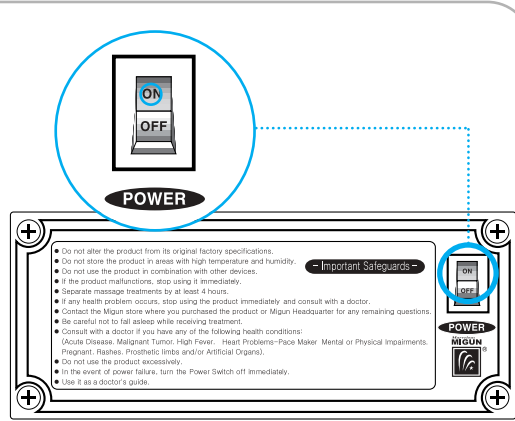

2

Turn on the external jade massage heads. The power switches are located on the side.

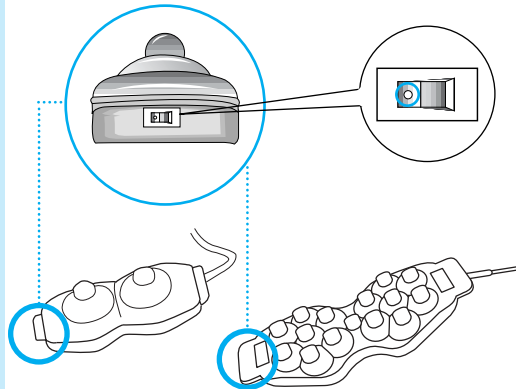

3

- a If any 'temperature/movement' button is pressed, the set temperature of the external jade massage heads appears on the display monitor.
- b The external jade massage heads LED, located on the lower right side of the remote control, will light up in green.

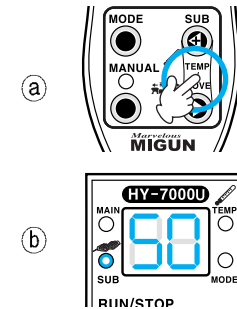

4

Select desired temperature by pressing either 'up' or 'down' button of 'temperature/movement' button.

- * The range of temperature is between 40~60°C(104~140°F) with an increment of 5°C (9°F).
- * Unless an internal temperature set button is pressed, the display monitor will alternate between selected operational mode and present temperature of the internal jade massage heads.
- * Present temperature of the external jade massage heads will not be displayed.

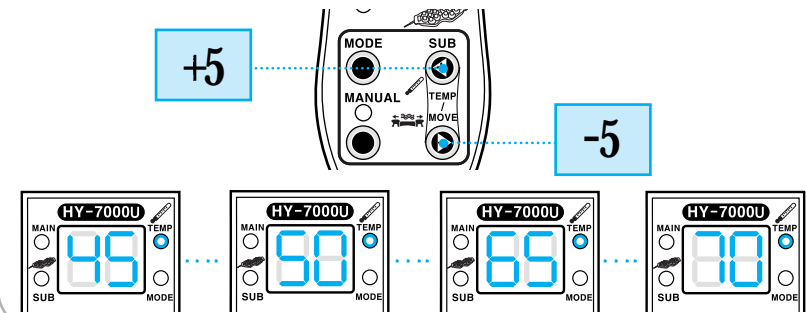



Operational Instruction

To Use External Jade Massage Head 1 and 2

5

Apply the external jade massage heads on desired areas of your body.

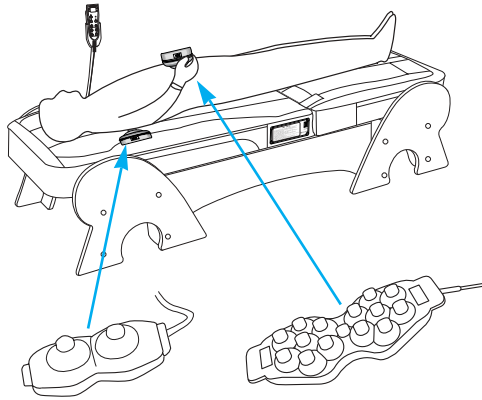

6

When a treatment session is done, turn off the external jade massage heads.

* Note: temperature may be changed any time during the operation.

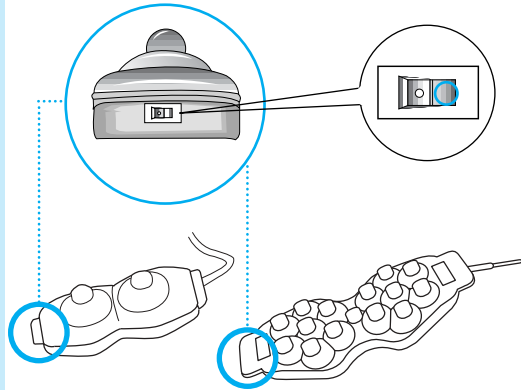

Proper Storage and Care

After Using The Product

1. If an external jade massage head was used, turn off the power switch located on the side of the massage head.
2. Turn off the main power switch, located on the right side of the product from the user's point of view.
3. Unplug the power plug.

Storage and Care for the Product

1. Store the product in an area that is well-ventilated and is between 50°F-86°F(10-25°C)
 2. Do not store or use the product in the environment with high humidity and temperature.
 3. Avoid placing the product in direct sunlight.
 4. Always place accessories that are not in use in their appropriate storage areas.
 5. Keep the product clean.
 6. Always disconnect power when cleaning.
 7. Do not place the product on any raised surface or platform (more than 1m or 3.28 feet). Dropping the product may cause a malfunction.
- * Cleaning instructions for extended use:
- 1) Remove dust from the product on a regular basis.
 - 2) Clean the top of the jade massage heads occasionally. Make sure that the light is always visible when it is in use.

How to Clean the Product

Caution Unplug the power plug before cleaning. Otherwise, electric shock may occur.



• **Mattress Cover (Synthetic Leather)**
Use a leather cleaner or a dry cloth to clean.

• **Frame**
Use a dry cloth with small amount of water or a furniture cleaner.

• **TC Net**
Remove dust using a vacuum cleaner.

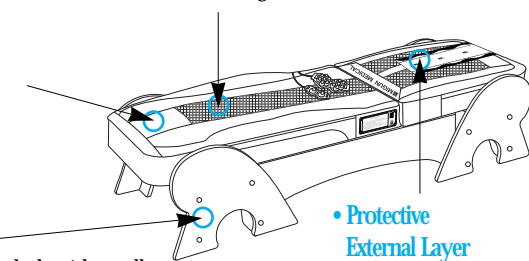

• **Protective External Layer**
Detach for cleaning, and do not apply too much force while cleaning.



Error Message/ Emergency

List of Error Messages

If the following error messages appear on the display monitor, stop using the product and contact the store where you purchased the product from or the Migun Headquarter.

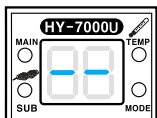

When the display monitor shows

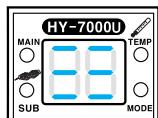

When the display monitor shows

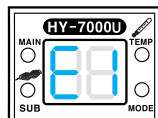

When the display monitor shows

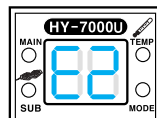

When the display monitor shows

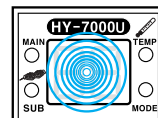

When an alarm continuously beeps

In case of an Emergency

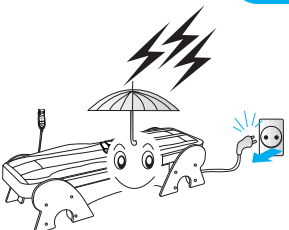

• Unplug the power cord when there is a lightning or thunderstorm.

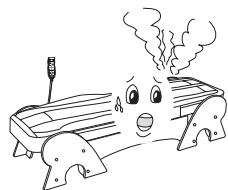

• When you smell smoke or if there's smoke coming out of the product, stop using the product immediately and contact the store where you purchased the product from or the Migun Headquarter.

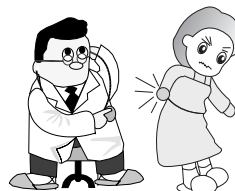

• If any health problem occurs, stop using the product immediately and consult with a doctor.

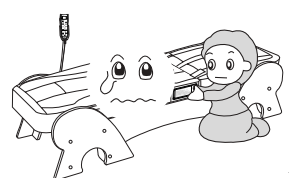

• When a power failure or malfunctioning occurs, turn the power switch off and stop using the product immediately.

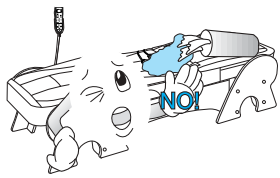
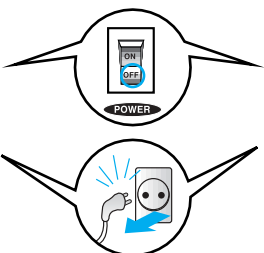

• If water is spilled on the product, turn the power switch off and unplug the power plug immediately. Contact the store where you purchased the product from or the Migun Headquarter.



Troubleshooting

Please check the following lists of problems before contacting Migun stores. Problem may not be the malfunctioning the product but a mistreatment.

Symptom	Check list	Do the following
LED on the remote control doesn't turn on.	Is the remote control cable disconnected?	Plug the cable into the remote control terminal properly.
	Is the power plug plugged into the outlet?	Plug the power plug into a correct 120V AC outlet.
	Is the main power switch turned off? Is the power outlet 120V AC?	Turn the main power switch on. Plug the power plug into a correct 120V AC outlet.
The internal jade massage heads do not move.	Does the display monitor show '00'?	It is normal before an operation starts. Press the start/stop button.
	Is the 'main' or 'lower' LED below/above the pause buttons on?	The movement is paused. Press a proper pause button once to resume the movement.
	Is the manual operation LED on?	The product is on the manual mode. Press a temperature/movement button to move the internal jade massage heads.
The external jade massage heads do not turn on.	Are the connecting cables for the external jade massage heads disconnected?	Plug the cables into the proper external unit terminals.
	Are the power switches of the external jade massage heads off?	Turn the power switches on.
	Is the power plug plugged into the outlet? Is the main power switch turned off?	Plug the power plug into a correct 120V AC outlet. Turn the main power switch on.
The temperature setting of the external jade massage heads cannot be controlled.	Is the manual operation LED on?	Set the product to an automatic operation to set temperature of the external jade massage heads.

- It's not malfunctioning even though the internal jade massage heads in the lower body move when the operation is stopped. They are moving to the starting point for the next operation.
- If you still have a problem even after checking all of the above, contact the Migun store where you purchased the product.



Expendable Items

Expendable Items

Item		period				
		1 Month	2 Month	3 Month	4 Month	1 Year
Tension	Consumers				Replace	
	Demonstration Centers			Replace		
Protective External Layers	Consumers	Wash				Replace
	Demonstration Centers	Wash			Replace	

- ※ For sanitary purposes, protective external layers should be washed 3 times more in summer than in winter.
- ※ The expendable items used in demonstration centers would wear out faster because of their frequent uses.
- ※ When expendable items are not properly changed or managed according to the schedule, a noise may occur during an operation. Even though it is not a malfunction, if the items are not properly changed, a severe damage may occur to the product.
- ※ When Tension is placed upside down, the operation might be noisy.

Expendable items list

- Protective external layers
- Tension
- Tension clipper
- Main cover
- Bearing box for the main body



Replacing Expendable Items

Replacing Expendable Items

Tension

- 1 Unplug the power plug.
- 2 Disconnect the connecting cable for the main and lower bodies. (Refer to pg 11)
- 3 Lift up the main body a little to detach the protective external layers. (Velcro under the product makes it easy to detach.)
- 4 Open up the mattress cover by unzipping it.
- 5 Release the rubber band, located on the middle of Tension.
- 6 Unclip the Tension clipper located at both ends of Tension (the main cover and bearing box for the main body) to replace Tension. Clip the clippers back in.
- 7 Put the rubber band back to tighten Tension up.
- 8 Put the mattress cover back on and close the zipper. Attach the protective external layers.
- 9 Connect the main and lower bodies together using the connecting cable. (Refer to pg 23)

Protective external layer

- 1 Unplug the power plug.
- 2 Disconnect the connecting cable for the main and lower bodies. (Refer to pg 11)
- 3 Lift up the main body a little to detach the protective external layers. (Velcro under the product makes it easy to detach.)
- 4 After replacing the protective external layer, connect the main and lower bodies together using the connecting cable. (Refer to pg 23)



Disposing Used Product / Manufacturer's Label

Disposing a Used Product

When replacing a product with a new one

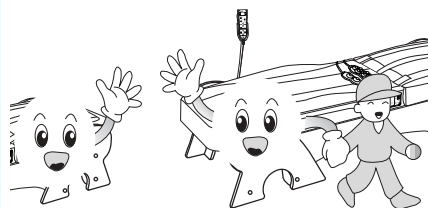

Migun will dispose the old product for free when replaced by a new one.

When disposing a used product



Follow the local garbage disposing process for home appliances.

Manufacturer's Label

HY-7000U

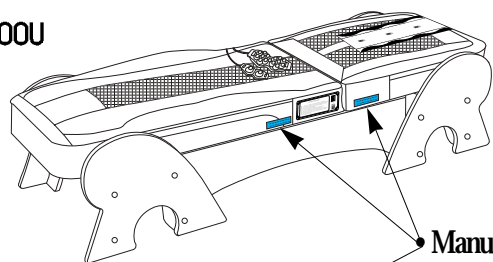

Manufacturer's Label : Apart 1EA

BOX (BOX Side)

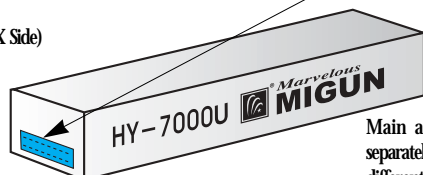

Main and lower bodies are manufactured separately, so the dates of manufacturing can be different.



Helpful Tips on Using the HY-7000U

Helpful Tips

1. Prior to a treatment, please see one of the Migun employees for instruction.
2. Please use the bed with extra precautions if you prefer to use it at a temperature higher than 60°C.
3. If any unexpected physical reaction arises during or after the treatment, consult with a doctor immediately.
4. Do not wear Nylon or Polyester material cloth such as stocking during the treatment. For best results, wear a white 100% cotton cloth.
5. Please use it with extra care if you have diabetes, you skin may not sense the heat properly.
6. Do not place the Jade Massage Head on a same area for more than 2 minutes. It may result in a possible skin burn.

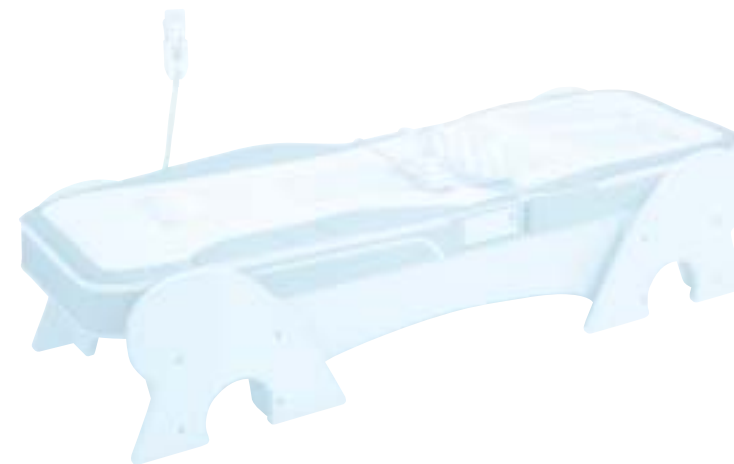

M E M O

M E M O

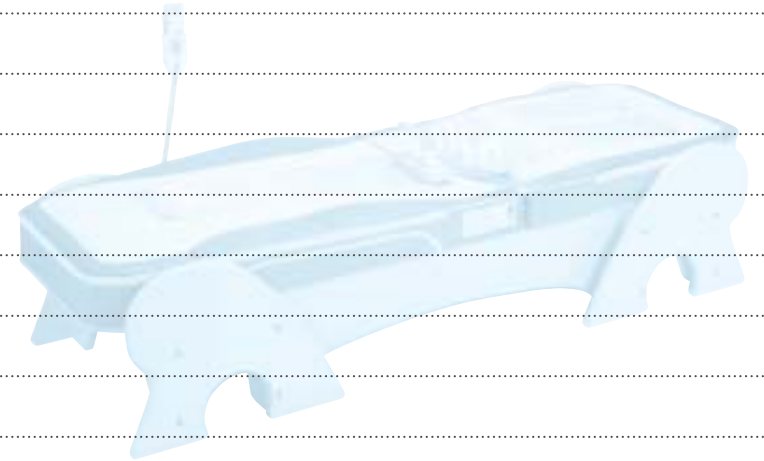
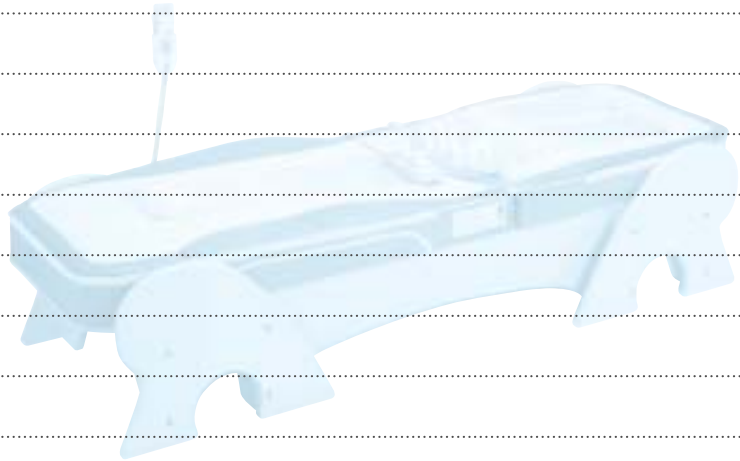

M E M O

M E M O

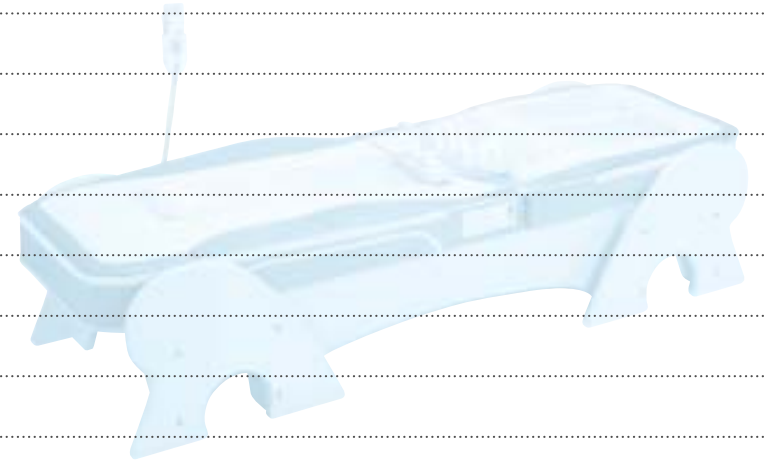
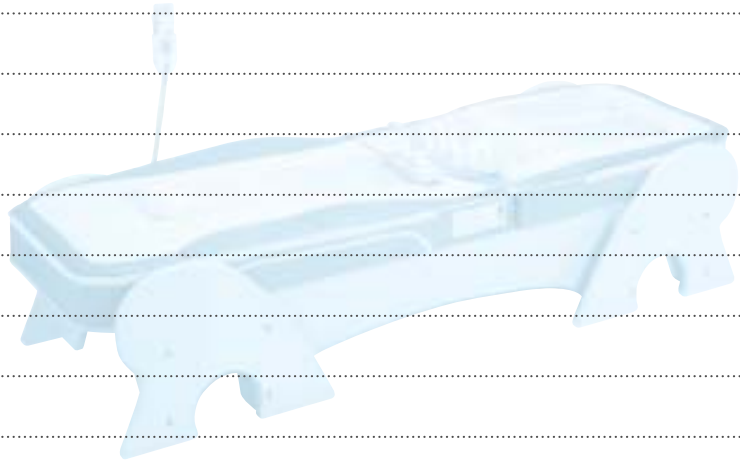



About Aftersales Service

- Please read the troubleshooting section carefully before contacting Migun. Migun will help you with questions or problems that are not answered by the troubleshooting section.
- When contacting Migun stores, please let us know the name of the product, the model number, a description of the problem (in detail), your phone number, your address, and your name.

Warranty

- Any defective materials and/ or workmanship of our product is warranted, free of charge, for a period of 12 months from the date of your purchase.
- The warranty is only effective when the information written on the card is true.
- The warranty is effective from the date of your purchase, so please let your sales person write down the date of your purchase on the warranty card.
- This warranty card will not be issued again.

Customer's Rights

You have a right to get a free service for a year if the product has a problem. However, if the problem is caused by a mistreatment or a natural disaster, some service charge would be applicable.

Void of Warranty (Service Charge is Applicable)

- ▶ Warranty is void, even during the period of warranty, if:
 - problems are caused by owners' carelessness
 - the product was used under conditions that are not recommended
 - the owner attempted to repair and/ or alter the bed in any way
 - problems occurred because any foreign object, food, drink, etc. is improperly placed on or in the product
 - parts from companies other than Migun are used
 - problems are on an expendable part
 - problems are caused by dropping or hitting the product
 - problems are caused because the product is plugged into an outlet that is not rated properly
 - services are provided by someone who is not a certified technician of Migun
 - problems are caused by not following this manual
 - (You can use the product longer if you follow the safeguards and precautions written in this manual)

Warranty Registration

Migun Thermal Massage System Warranty

- This warranty is only effective when this card is completed and confirmed at authorized dealer you purchased the product.
- You can contact the store you purchased product or Migun U.S.A. headquarter to get warranty service.
- Do not let anyone repair the product if he/she is not a certified technician by Migun Ltd. (due to the use of specially designed circuit board)
- Some service charge might be applicable when the product is malfunctioning due to mistreatment or intentionally applied damage.

Product Name	MIGUN Thermal Massage System			Model Name	HY-7000U
Warranty Period	1 year from the date of purchase			Serial Number	
Date of Purchase	Month	Date	Year	Place of Purchase	
Customer Information	Name				
	Address				

- To ensure service under warranty, please let your dealer complete this card when you purchase the product.
- Please keep this card safely. You need to show a completed warranty card with the date of purchase when asking for a service.

1. The warranty is only effective as per the information written on the card.
2. The period for warranty starts from the date of your purchase, so please let your sales person complete the information on the warranty card. (If the date of purchase is not written, the warranty period is considered to be started from three months after the date of manufacture.)
3. If the product is used for purposes other than personal use (business use, or use under undesirable conditions), the warranty period would be 6 months.
4. This warranty card will not be issued again.

* possession period of main parts: 5 years *possession period of core parts: 1 year after purchase (6 month at Demonstration Center)

Nature of Damage	Compensation Particulars	
	Within the period of warranty	After the period of warranty
Any damages or technical defects caused during normal operation	A major repair is required within 7 days after purchase	Refund or product exchange
	A major repair is required within 1 month after purchase	Product Exchange
	Damage caused during the process of transportation and installation	
	In case of a product for repair is lost by the dealer	Product Refund
	In case of a repair cannot be done because the necessary parts are not provided by the dealer	Repair with similar parts or refund with a penalty ratio
Repairable defects	When identical defect occurs 3 consecutive times	There will be no repairing charge
	When identical defect occurs 4 consecutive times	Merchandise exchange / refund with penalty ratio
	When different defect occurs 6 consecutive times	
Damage caused intentionally by user or by mistake	Condition of the product is beyond repair	Not Applicable
	Condition of the product is under repair	Repairing charge will be applied
Penalty Ratio	Product Condition	
	Return condition is satisfactory	Penalty Ratio
	Repair is impossible due to damage	20%
	The value of the merchandise has been divested due to a serious damage	85%

• This term is based from March 2004, and it can be changed without notice depending on the condition of Migun Ltd.



Healthy Smile



Certificate of ETL



Awarded Golden Industrial Merit



*Golden Prize of Seoul International Patent Invention Fair 2012



*Golden Prize of Korea Patent Technology Ceremony



*Golden Prize of IA Special Prize of the 30th International Exhibition of Invention Patents in Geneva



Certificate of CE



U.S.A. Patent

MIGUN
MIGUN

Migun Thermal massage System HY-7000U Owner's manual

Migun wishes all the people of the world become happier and healthier

Healthy Smile

Migun is a creative company that cherishes the future. In a new millennium, Migun will help you to make a new level of health care.



Marvelous
MIGUN
www.migunworld.com

828-684-1800



Marvelous
MIGUN

Please read this manual carefully for safe and effective use of your Migun bed.
Please keep this manual safe and refer to it when necessary.